

Technical requirement 技术参数:

1. Electrical Characteristics Test 电气性能检验
 - 1.1 Products 100% for electrical test. 成品100%电性测试。
 - 1.2 Insulation resistance: No less than 100MΩ of 500V DC/0.4S.
绝缘阻抗: 大于或等于100MΩ 500V DC/0.4S.
 - 1.3 Dielectric strength 耐电压
 - 1.3.1 Between two conductors 2500_0^{200} V AC for 1.0s Trip-current 1.0mA max.
导体与导体之间 2500_0^{200} V AC /1秒, 漏电流 1.0mA(max)。
 - 1.3.2 Between conductor and body 4000_0^{200} V AC for 1.0s Trip current 1.0mA max.
导体与本体之间 4000_0^{200} V AC /1秒, 漏电流 1.0mA(max)。
2. Mechanical Characteristics Test 机械性能检验
 - 2.1. Withdrawal force 拔出力
 - 2.1.1 For checking each PIN independently from the standard-gauge below 1.5N(Min) Keep for 3S or more.
标准量规对连接器插孔单PIN保持力为最小1.5N保持3秒以上。
 - 2.1.2 For checking Integral withdrawal force **50N(MAX)** from maximum standard gauge. 标准量规(最大值)检查整体拔出力 **50N(MAX)**。
3. Finished product conditions 成品状态
 - 3.1 The attachment plug front show the test mark of " T ".
插头主视面须有测试标志 " T "。
 - 3.2 The dimension with "▽" must be control and inspected importantly.
带"▽"尺寸需重点管控和检验。
 - 3.3 material and product comply with Doc No."QW-Q-043" 《material-and product-of restricted substance control specification.
物料及成品必须符合QW-Q-043 《材料及成品限用物质管理规范》
4. The standards for the products.: 产品标准:
 - 4.1 The cord shall comply with IEC 60227. 线材须符合IEC60227;
 - 4.2 The plug and connector shall comply with IEC 60320. 插头和连接器须符合IEC60320;

REV.	DESCRIPTION	DESIGN	APPROVAL	DATE
X	NEW	H.Q SONG	BG Yang	2014.07.31

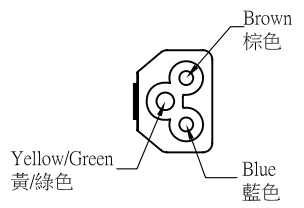
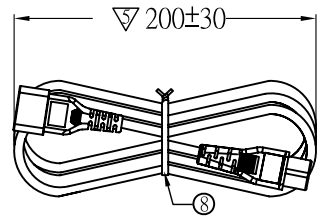
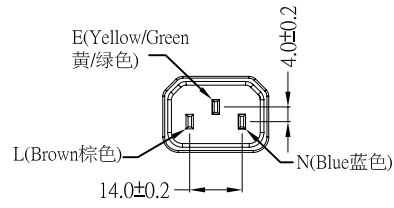
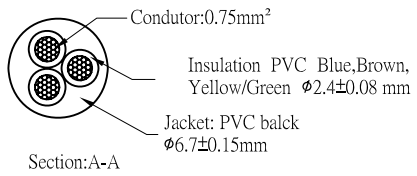
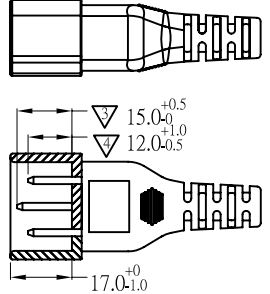
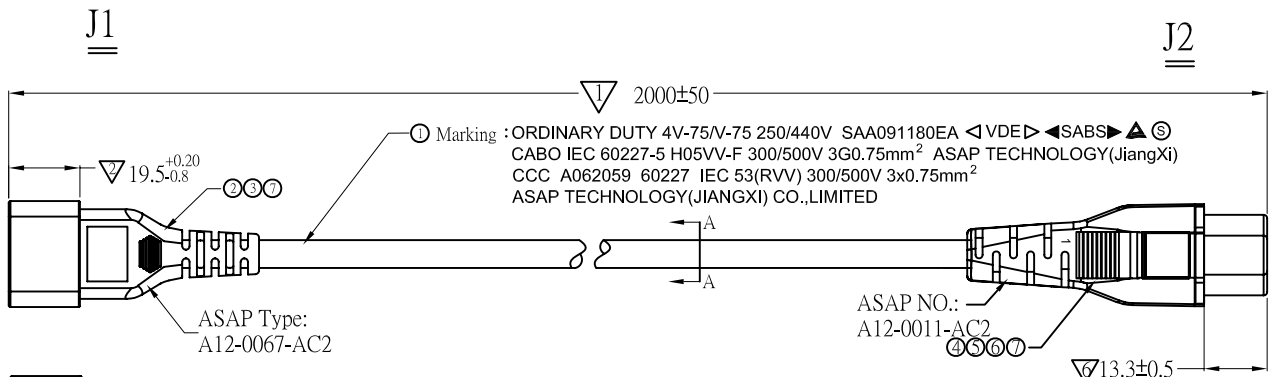

Wiring method:
 J1 cord J2
 E — Yellow/Green — E
 L — Brown — L
 N — Blue — N

Marking details J1 see the second page
(J1端标志详见第二页)

Marking details J2 see the second page
(J2端标志详见第二页)

ITEM	NAME	DESCRIPTION	UNIT	QTY
⑧	TIE	BLACK PE tie hanking cord and meeting RoHS.	pcs	1
⑦	PLASITC	55P BLACK PVC pellets meeting RoHS and UL94 V-0.	g	1
⑥	TERMINAL	O type terminal with free point 0.4*26.4*13.0, Phosphor bronze	pcs	2
⑤	TERMINAL	O type terminal with free point 0.4*26.4*16.0, Phosphor bronze	pcs	1
④	HOUSING	Housing of C5, PBT material, black	pcs	1
③	HOLDER	Holder, PBT material, black.	pcs	1
②	BLADE	Blade 2x4mm, copper, nickel-plated	pcs	3
①	POWER CORD	60227 IEC 53 (RVV) 300/500V 3x0.75mm² Ø6.7±0.15mm BLACK	mm	NA

X.±	X.°±	UNITS
.X±	.X°±	mm
.XX±	.XX°±	MATL
.XXX±	.XXX°±	
		FINISH
		Q'TY

P/N: 42 2985		
PART NO: L8CAC015-DT-R	TITLE: VDE C14 To C5 L2.0M Black	
APPD: 杨保根	DWG NO: L8CAC015-DT-R	
CHKD: 欧阳光仁	SCALE NONE	SHEET 1/2
DR: Huoqing Song		

THESE DRAWINGS AND SPECIFICATIONS ARE THE PROPERTY OF ASAP TECHNOLOGY(JIANGXI)CO., LIMITED AND SHALL NOT BE REPRODUCED, COPIED OR CUED IN ANY MANNER WITHOUT THE PRIOR WRITTEN CONSENT OF ASAP TECHNOLOGY(JIANGXI)CO., LIMITED.

A

8 7 6 5 4 3 2 1

E E

D D

C C

B B

A A

8 7 6 5 4 3 2 1

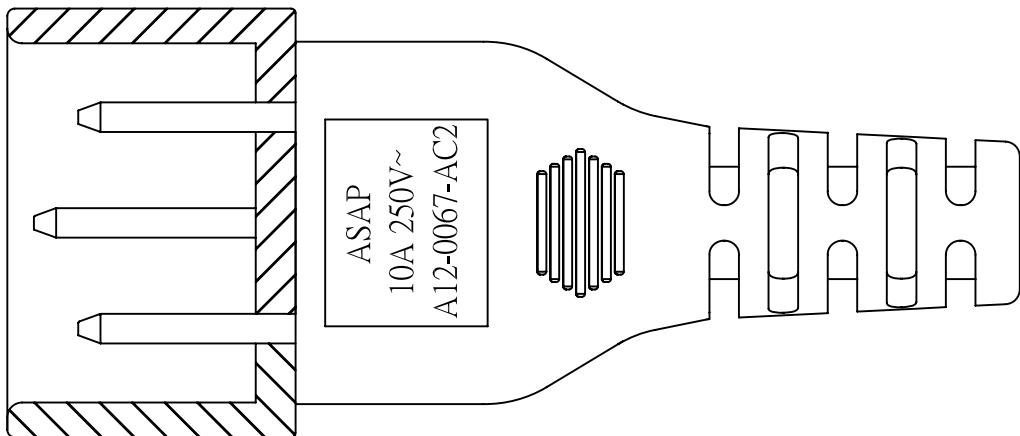
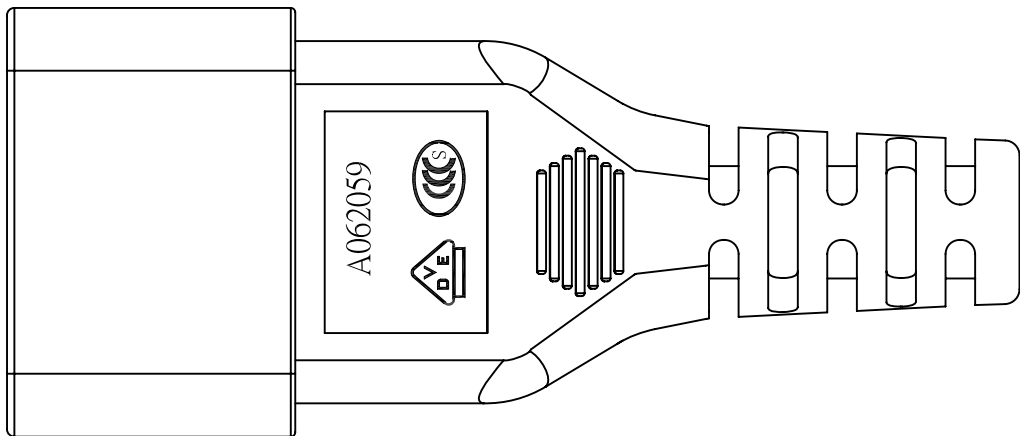

J1Marking
J1端標誌

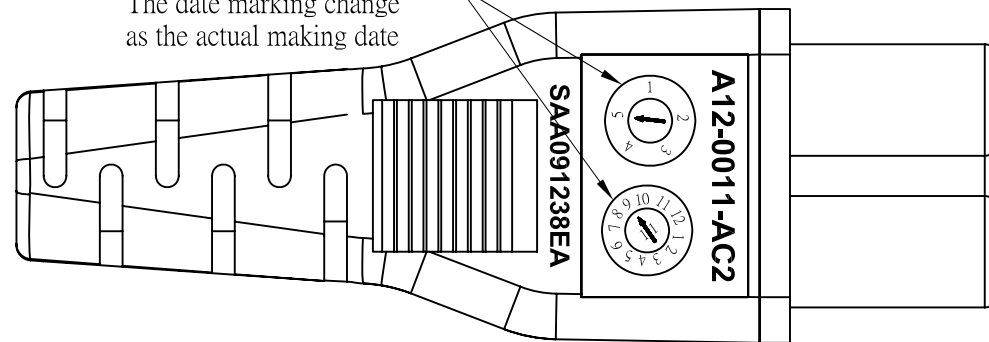
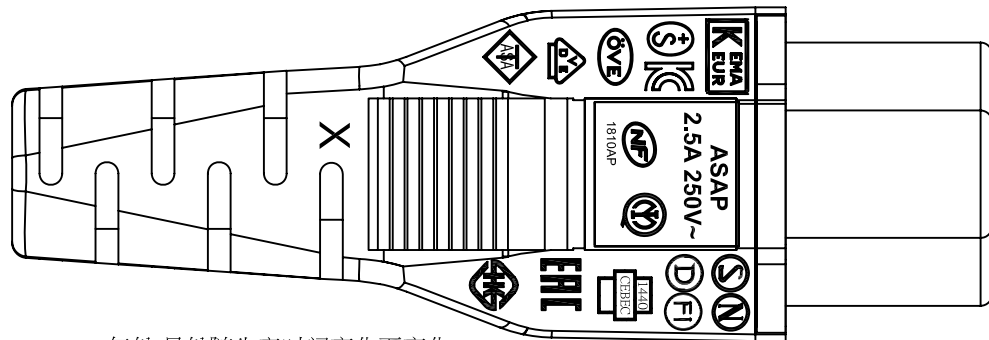

年份,月份随生产时间变化而变化

The date marking change
as the actual making date

J2Marking
J2端標誌

X.±	X.°±	UNITS mm	P/N: 42 2985				
.X±	.X°±						
.XX±	.XX°±	MATL	PART NO: L8CAC015-DT-R	TITLE: VDE C14 To C5 L2.0M Black			
.XXX±	.XXX°±		FINISH	APPD: 杨保根	DWG NO: L8CAC015-DT-R		
THESE DRAWINGS AND SPECIFICATIONS ARE THE PROPERTY OF ASAP TECHNOLOGY(JIANGXI)CO., LIMITED AND SHALL NOT BE REPRODUCED, COPIED OR CUED IN ANY MANNER WITHOUT THE PRIOR WRITTEN CONSENT OF ASAP TECHNOLOGY(JIANGXI)CO., LIMITED.			CHKD: 欧阳光仁		SCALE	SHEET	REV.
			Q'TY		DR: Huoqing Song	NONE	2/2